

WAVE Acoustic GRADATION Panel Installation Guide

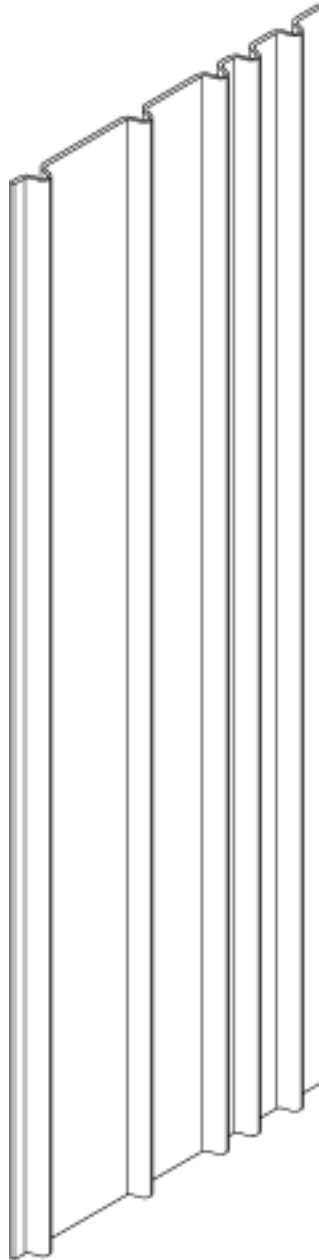

Tools (varies based on Installation method):

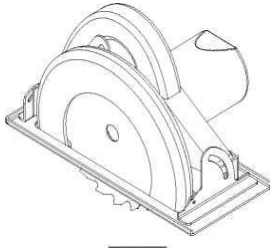

Circular Saw

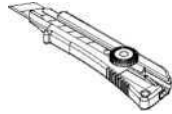

Utility knife



Glue gun

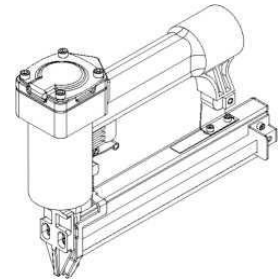

Nail gun

Cutting panels to size

1. Measure how many full panels fit on the surface you want to cover

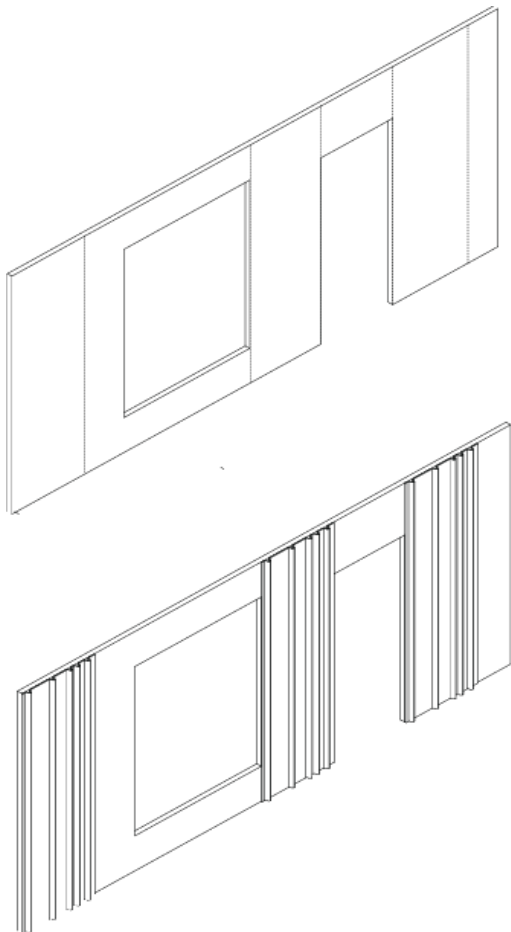

 The dimensions of a full Gradation panel are 2390 x 790 mm

2. Measure the remaining blank sections

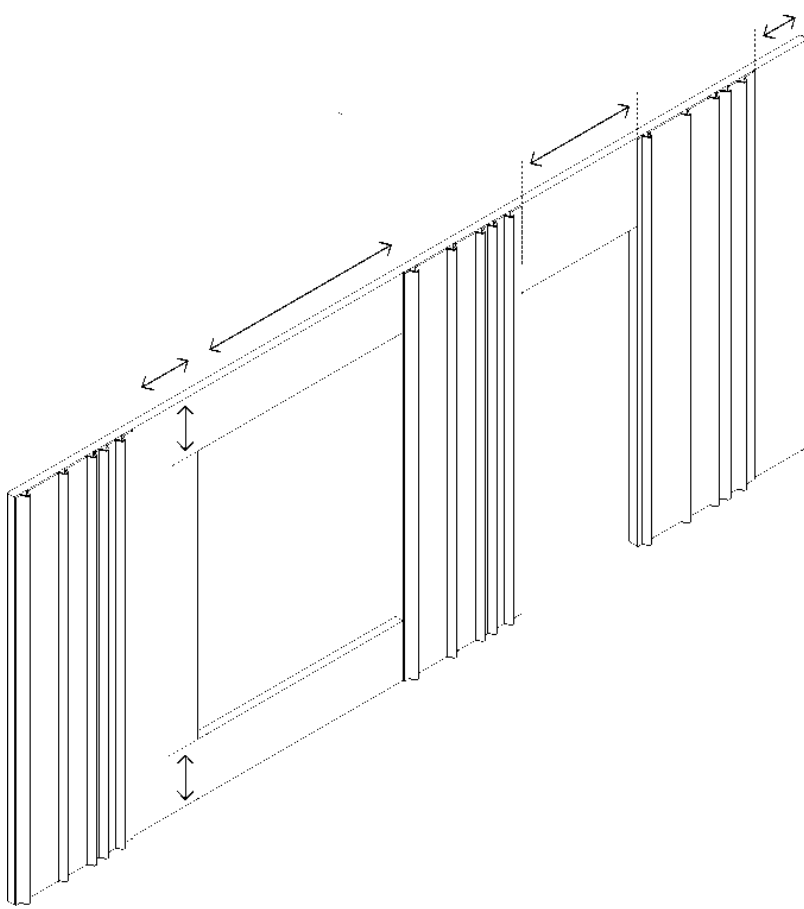

3. Measure the missing pieces

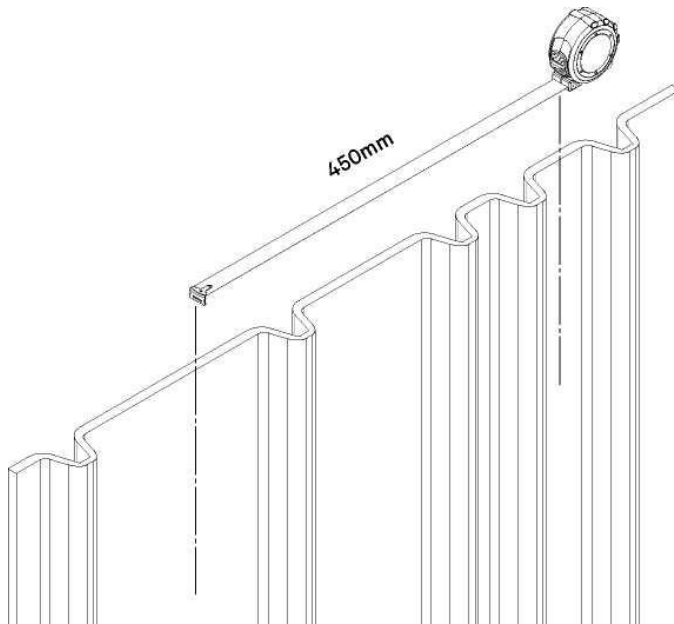

! The easiest way to measure where to cut the required piece is to place a tape measure along the top of a panel. Slide it until you find a position where the ends of the tape measure coincide with flat sections on the panel

4. Cut the missing pieces out of a panel

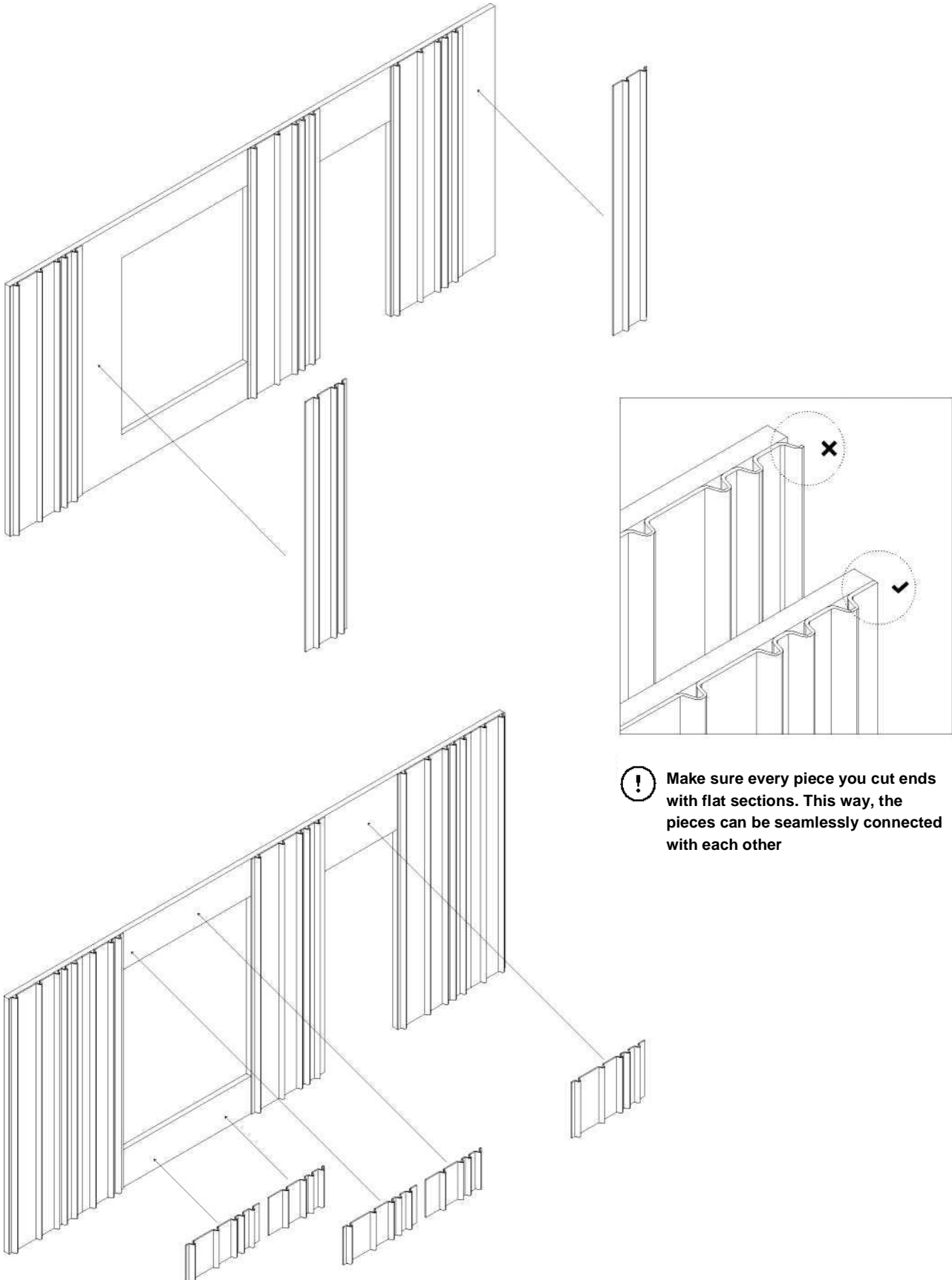

! Make sure every piece you cut ends with flat sections. This way, the pieces can be seamlessly connected with each other

Applying GRADATION panel using nail gun

1. Prepare a wooden framework on the surface you

! Make sure the frame is levelled

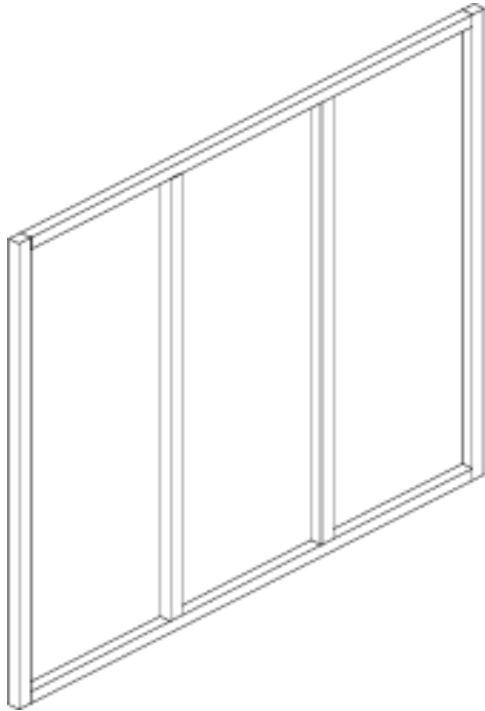

2. Place the first panel against the framework and attach it using the nail gun

! For a better grip, the nails should be applied at an angle of approximately 45°

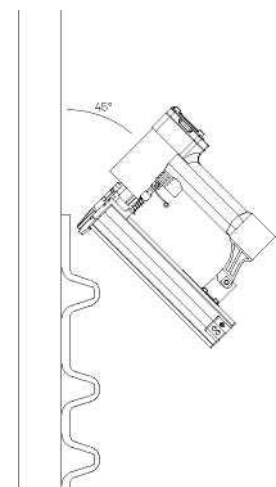
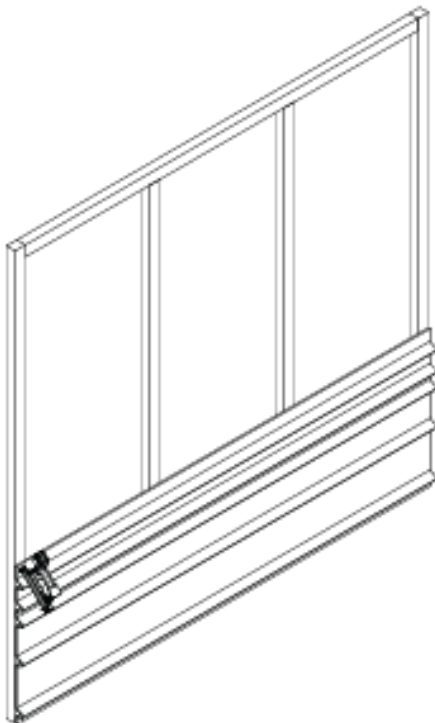

3. Repeat the previous step until the installation is complete

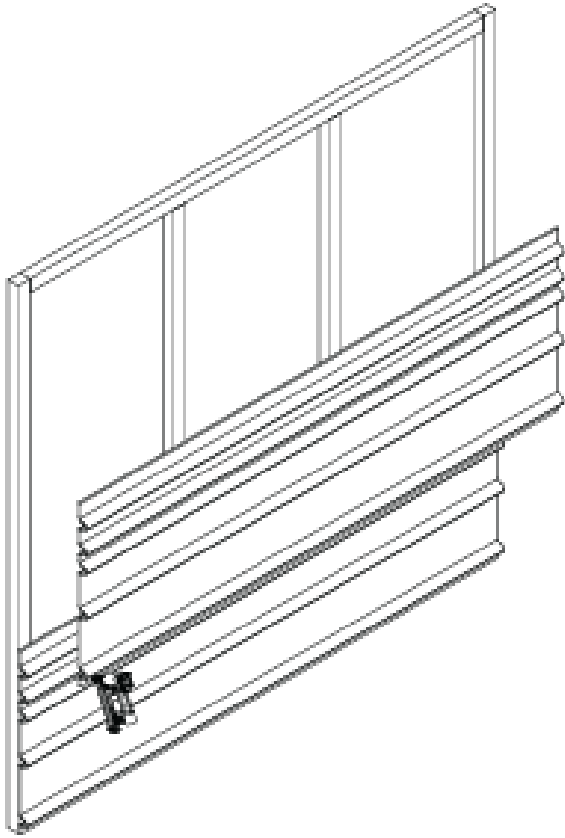

Applying GRADATION panel with glue gun

1. Apply the adhesive on the back side of the panel following the manufacturer instructions



Make sure the surface is clean and dust-free

Distribute the glue evenly on the flat parts of the panel

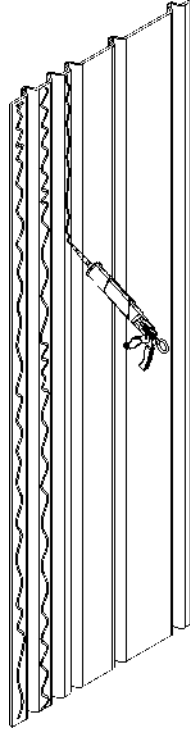

2. Place the first panel against the wall and press it firmly

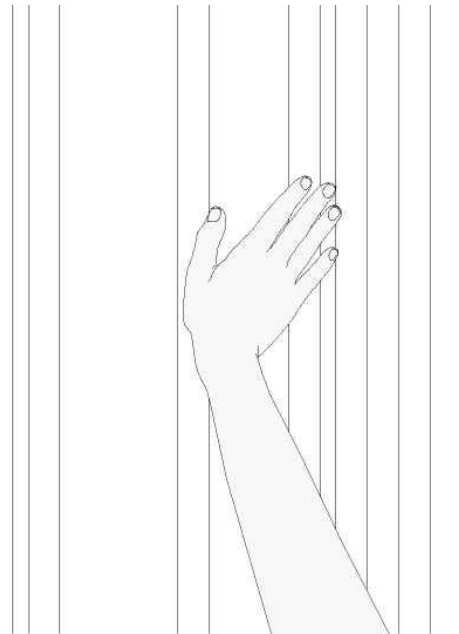
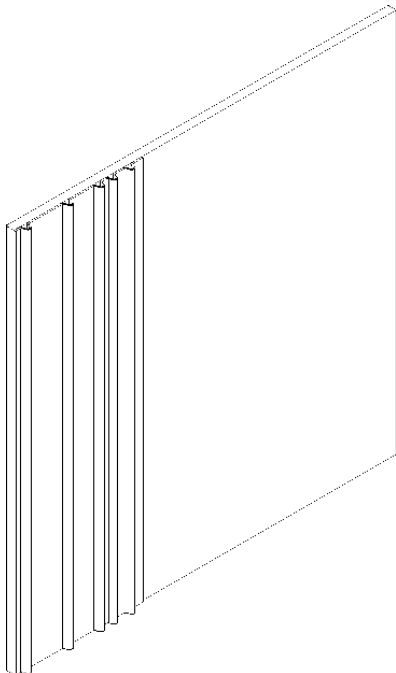

-
3. Allow the adhesive to cure. The curing time may vary, follow the manufacturer recommendations.

